



## EXALUS TR7

Spółka z ograniczoną odpowiedzialnością sp.k.  
Kuchary 24F  
63-322 Gołuchów  
[www.exalus.pl](http://www.exalus.pl)

# MOTOR USER MANUAL

## SSR-BIDI

The motors operate  
at 868 MHz

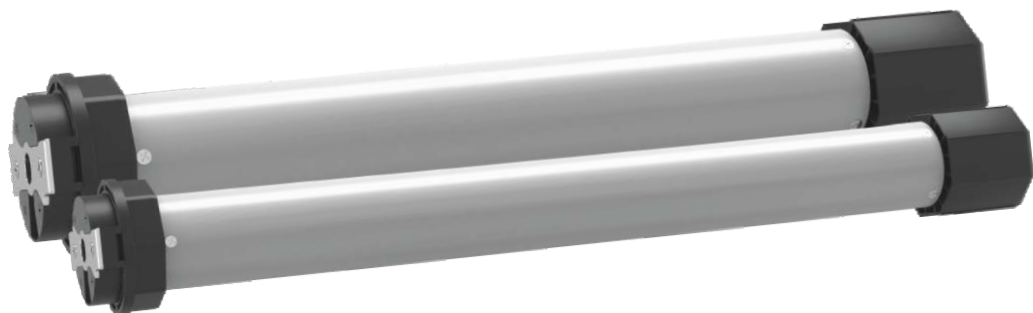

**NOTE:** The radio receiver can communicate directly only with NX-BIDI and PX-BIDI remote controllers.

Use only after setting the end positions (auto calibration, manual setting of end positions).

## 1. CONNECTION DIAGRAM:

- Connection diagram of the radio drive with a switch

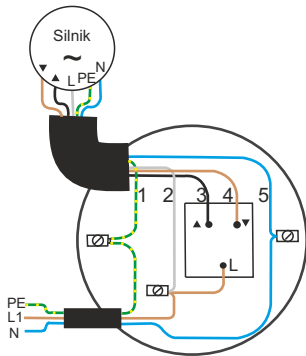

1 = PE - protective conductor (yellow and green)

2 = L1 - line conductor (gray)

3 = UP (black)

4 = DOWN (brown)

5 = N - neutral conductor (blue)

*Note: It is recommended to use two-key switches (monostable) for wired control.*

- Connection diagram of a radio drive without a switch

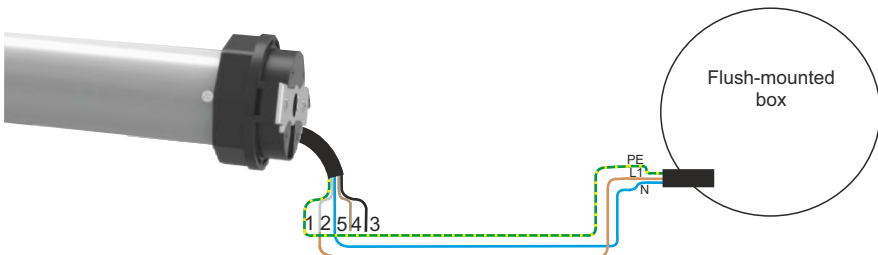

1 = PE - protective conductor (yellow and green)

2 = L1 - line conductor (gray)

3 = UP (black)

4 = DOWN (brown)

5 = N - neutral conductor (blue)

**IMPORTANT:** After applying voltage to the drive, the **BOOTLOADER** is activated first (approx. 5 seconds). After its activation, the process of receiving the signal from remotes - confirmed with a short UP/ DOWN movement - is started and lasts about 10 seconds. Then, switching to normal operation is confirmed with an UP/ DOWN movement.

**NOTE:** While programming, only the drive that is being programmed should be connected to the power supply.

## 2. SETTING THE MOTOR IN THE AUTOCALIBRATION MODE (AUTOMATIC END POSITION SETTING):

**NOTE:** Autocalibration cannot be performed from the bottom. It should start at least half the length of the roller shutter. Proper automatic calibration process is pre-conditioned with stable sub-surface (window sill) and bottom lath stoppers (buffers) that prevent the profile from sliding in the upper part of the guide rails.

1. Apply voltage to the motor (confirmed with a short UP/ DOWN movement).
2. Select the channel on the remote and press the STOP button (confirmed with a short UP/ DOWN movement), the remote has been assigned to the motor and operates in the non-support mode.
3. Press the P2 button on the remote → the automatic motor calibration starts (wait until the motor performs full cycles and finishes the autocalibration).
4. The motor has been set. The remote is in the support mode.

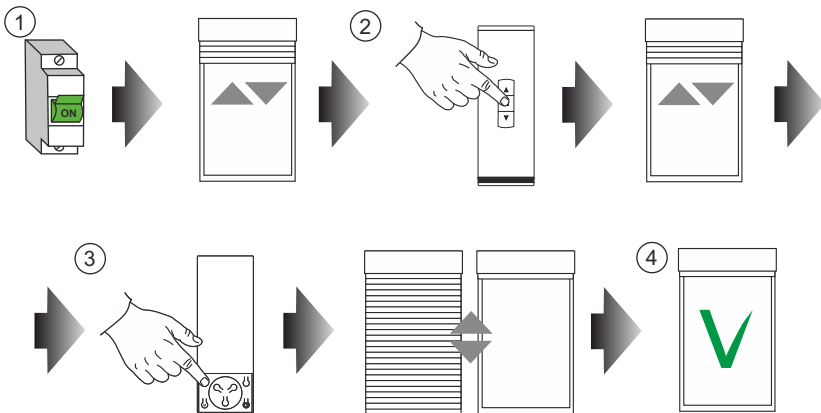

### 3. MANUAL ADJUSTMENT OF END POSITIONS:

*IMPORTANT: The correct setting of the end positions either manually or by means of self-calibration is a requisite of the proper functioning of the SSR-BIDI motor.*

1. Apply voltage to the motor (confirmed with a short UP/ DOWN movement).
2. Select the channel on the remote and press the STOP button (confirmed with a short UP/ DOWN movement), the remote has been assigned to the motor and operates in the non-support mode.
3. Hold the STOP button for 3 seconds (confirmed with a short UP/ DOWN movement) → switching to the manual end position setting procedure.
4. In the case of inverted control outputs (directions), hold the STOP button for 3 seconds (confirmed with a short UP/ DOWN movement).
5. TOP end position:
  - a. go to the selected location
  - b. press the P2 button (confirmed with a short UP/ DOWN movement)
  - c. press the UP button (confirmed with a short UP/ DOWN movement)
6. BOTTOM end position:
  - a. go to the selected location
  - b. press the P2 button (confirmed with a short UP/ DOWN movement)
  - c. press the DOWN button (confirmed with a short UP/ DOWN movement)
7. To finish programming, press the P2 button twice (confirmed with two short UP/ DOWN movements).

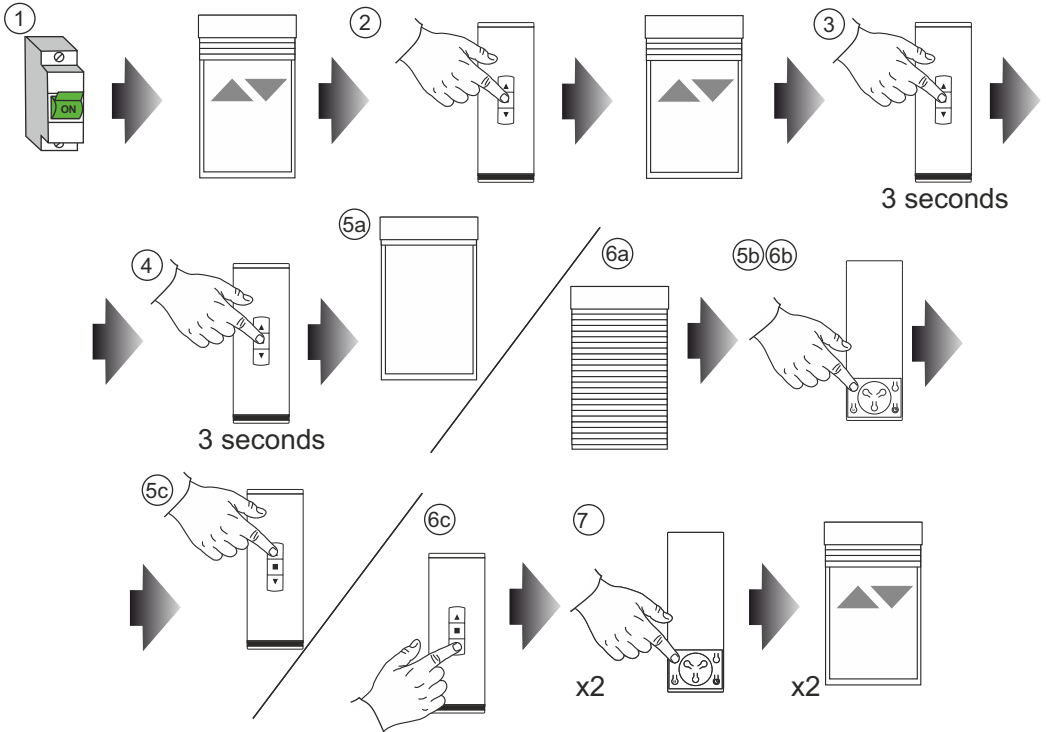

## 4. SETTING RESET:

1. Apply voltage to the motor (confirmed with a short UP/ DOWN movement).
2. Press the P2 button (confirmed with a short UP/ DOWN movement).
3. Press the UP button (confirmed with two short UP/ DOWN movements), a complete motor reset will be performed and all remotes will be listed.

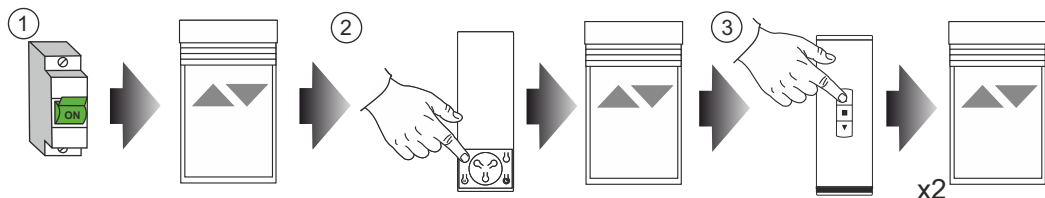

## 5. COPYING REMOTES:

1. Press the P2 button twice (confirmed with two short UP/ DOWN movements) on the channel to be copied.
2. Press the STOP button (confirmed with a short UP/ DOWN movement) on the selected channel.

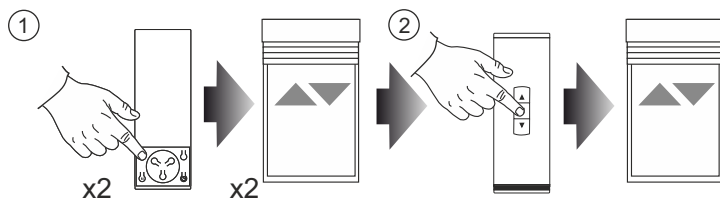

## 6. CORRECTING THE END POSITIONS:

1. Press the P2 button three times (confirmed with three short UP/ DOWN movements)
  - a. UP button → autocalibration
  - b. STOP button → edition of the manual end positions - see point 3 (5, 6, 7)
  - c. DOWN button → recalibration

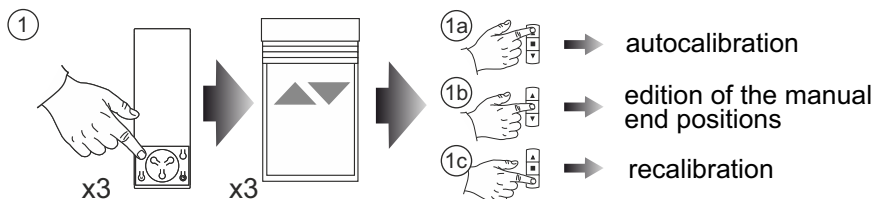

## 7. INTERMEDIATE POSITION:

1. Set the roller shutter in the selected intermediate position
2. Hold the STOP button for 5 seconds (confirmed with a short UP/ DOWN movement) (the intermediate position has been saved)
3. To activate the intermediate position, press the STOP button with the roller shutter stopped.
4. To remove the intermediate position set, hold the STOP button for 5 seconds (confirmed with a short UP/ DOWN movement) after the roller shutter has been set to the programmed position.

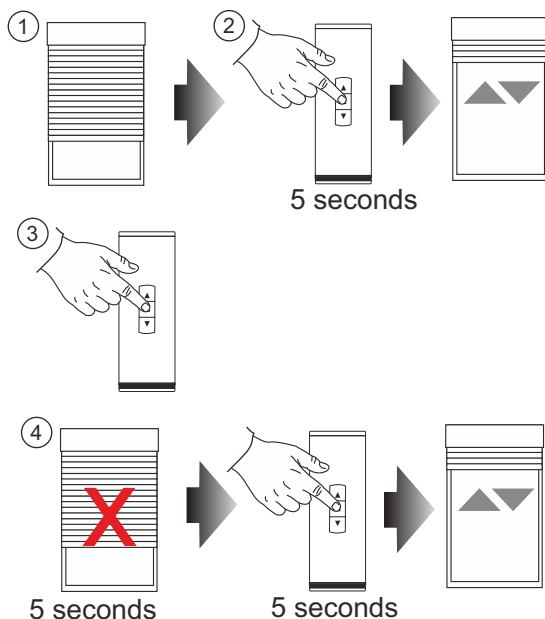

## 8. FUNCTIONALITIES OF THE SERVICE BUTTON:

1. Holding for 2 seconds → assigning/ deleting remotes with the STOP button
2. Holding for 5 seconds → autocalibration
3. Holding for 10 seconds → complete reset (confirmed with two short UP/ DOWN movements)
4. Holding for 15 seconds → exit without taking any action (confirmed with three short UP/ DOWN movements)

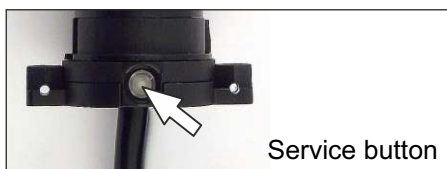

## 9. ADDING THE DRIVE TO THE TR7 CONTROL UNIT:

1. After logging to the control unit, open the menu in the left, upper corner of the screen and select "Configuration of devices".
2. Open the tab "New" in the top bar.
3. Press "Find devices" button. The control unit will start searching for drives and other devices which will be displayed on the list.

*Note: If the drives fail to appear on the list of devices, this means that they have been switched off for too long for the drives to send identification signals. By activating the drive via a remote control or button, or by switching it off and connecting it to power supply again, you will be able to find the drive again on the list.*

*Note: If the drive has already been assigned to another control unit and has not been properly removed thereof, it is necessary to reset the drive in order to assign it to another control unit.*

4. Press the down arrow, on the right side of the drive name and then, press '+' button.
5. Assign the device with a name that will easily identify it in future (e.g. Salon 1). If you press the "Identify channel" button, the drive being added will move up and down. The drive is added after the "Save" button has been pressed.

## 9. MOTOR RESET AND STARTING AUTOCALIBRATION WITH THE KEYS:

1. After turning on the voltage, wait for the first UP/ DOWN movement.
2. Then press and hold the key (for about 1-2 seconds after the first UP/ DOWN movement - if pressed before the first movement or during the first movement, the function will not work - protection against non-push button installation):
  - Up - to reset the motor
  - Down - to activate the autocalibration
3. Wait for the motor to make the second UP/ DOWN movement
4. After making the second UP/ DOWN movement, release the key within 3 seconds:
  - The motor reset is confirmed with two UP/ DOWN movements
  - If the down key is pressed - autocalibration is activated
5. If between the first and the second UP/ DOWN movement, the button is pressed for a short time or released, no function will be activated
6. If for some reason we do not want to reset/ start autocalibration, do not release the key for 4 to 5 seconds after the second UP/ DOWN movement, then – similarly to the service button - "TIMEOUT" is detected and the function is canceled

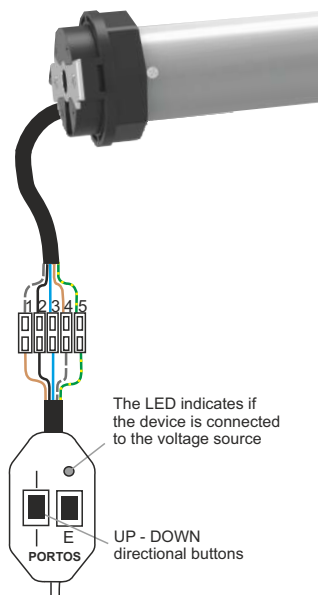

- 1 = L1 - line conductor (gray)
- 2 = UP (black)
- 3 = N - neutral conductor (blue)
- 4 = DOWN (brown)
- 5 = PE - protective conductor (yellow and green)